



Tischbohrmaschine

BM-21

Art. Nr. 27021.01.000

Preis inkl. MwSt. CHF 495.00

Schnellübersicht:

- LED-Arbeitsleuchte, verstellbar
- Präzisions-Schnellspannbohrfutter 0-16mm
- Drehzahlverstellung mittels Keilriemen
- 5 Drehzahlen
- 1-touriger Motor
- Separater Notausschalter
- Softhandgriffe
- Gesicherter Späneschutz
- Deckel-Endschalter

Technische Daten:

Motorleistung	0.45 kW
Motorspannung	230 Volt
Bohrleistung in Stahl	16 mm
Bohrhub	65 mm
Bohrspindel	MK 2
Anzahl Drehzahlen	5
Drehzahlbereich	660-2500 U / min ⁻¹ (660/960/1440/1850/2500)
Tischbelastung	30 kg
T-Nutenbreite	12 mm
Gewicht	36 kg



Jahre



Jahre

Vermassung BM-21

Angaben in mm

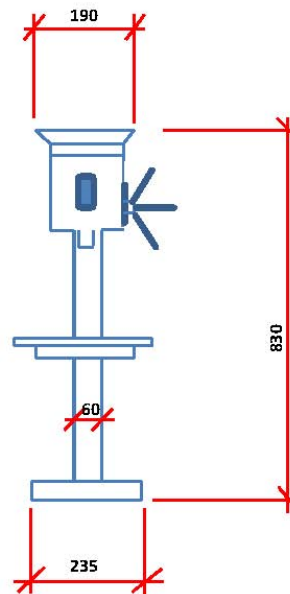
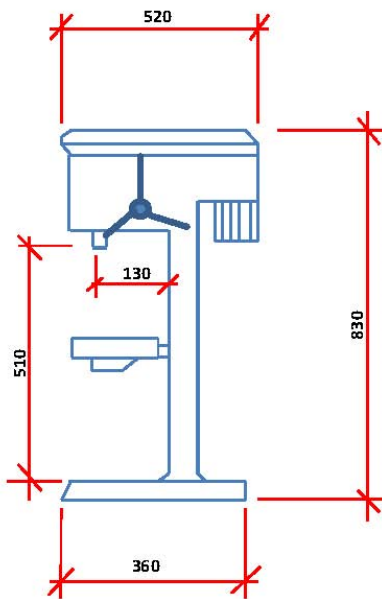

Tischabmessung: 200 x 200 mm



Jahre

Lieferumfang:

- Betriebsanleitung D / F
- Präzisions-Schnellspannbohrfutter 0-16mm, B 16
- Kegeldorn MK2 / B16, Art. 27010.90.000
- Austreibdorn
- LED-Arbeitsleuchte

Passendes Zubehör:

<p>Art. Nr. 27010.55.000 3-Weg Maschinenschraubstock Backenbreite 100mm mit Prismenbacke</p> <p>Preis inkl. MwSt. CHF. 135.00</p>	
<p>Art. Nr. 27030.91.000 T-Nutenschraube 12mm, M 10 komplett</p> <p>Preis inkl. MwSt. CHF 15.50/Stk.</p>	
<p>Art. Nr. 27010.85.000 Hochpräzisions-Schnellspannbohrfutter 3-16 mm, B 18 Backen speziell gehärtet und geschliffen für Hochpräzision</p> <p>Preis inkl. MwSt. CHF 125.00</p>	
<p>Art. Nr. 27010.92.000 Kegeldorn MK2 / B18</p> <p>Preis inkl. MwSt. CHF 19.90</p>	
<p>Art. Nr. 27099.00.000 Maschinenstandfuss zu Tischbohrmaschinen Abmessungen: 550 x 350 x 850mm Gewicht 32kg</p> <p>Preis inkl. MwSt. CHF 295.00</p>	

Art. Nr. 27010.98.000
Spannwerkzeugsatz 52-tlg.
T-Nutenbreite 12 mm / M10

Preis inkl. MwSt. CHF 150.00

